

SERIES STORAGE ATHENA

- FOR AUTOMATIC STORAGE SYSTEMS
- FOR AUTOMATIC HANDLING
- FOR MANUAL HANDLING
- SHOCK RESISTANT
- OIL RESISTANT



Resistant to high and low temperatures



Oil resistant



The stacking containers marked with this symbol can be used to store foodstuffs



ABS COVERS FOR ATHENA STACKING CONTAINERS



■ 07

ORD. NO.

DIM. mm

F VW 0006 00 07

1200x1000x70

Standard colour ■



Example of use of the cover and of the pallet



■ 07

ORD. NO.

DIM. mm

F VW 0007 00 07

1200x800x70

Standard colour ■

GREY
F. 01

BLACK
F. 07

KEY ■

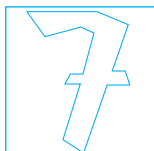

The stacking containers marked with this symbol can be used to store foodstuffs.



Containers with this symbol are made of completely recyclable plastic material.



DIMENSIONS = 300x200 mm

SERIES STORAGE ATHENA

PLASTIC PALLETS



ORD. NO.	EXTERNAL DIM. mm
F PU 2240 00 13	1200x800x150 h
Load capacity on floor kg 4000	
Load capacity on fork lift truck kg 1500	
Weight kg	13,70

ORD. NO.	EXTERNAL DIM. mm
F PU 3240 00 13	1200x1000x150 h
Load capacity on floor kg 4000	
Load capacity on fork lift truck kg 1500	
Weight kg	16,70

Plastic pallets for **Athena** and **Thema** containers with galvanised steel edges on all 4 sides



ORD. NO.	DIM. mm
F PA 2451 A0 01	300x200x120 h
External dim. mm	300x200x120 h
Internal dim. mm	260x160x100 h
Capacity litres	5
Weight gr.	450
Standard colour*	■
Bottom	solid
Long sides	closed
Short sides	closed
Lifting	bars

Label holder: ORD. NO. **F PZ 0010 00 99**
See page G15

■ *On request other colours available



ORD. NO.	DIM. mm
F PA 2851 A0 01	300x200x170 h
External dim. mm	300x200x170 h
Internal dim. mm	258x160x154 h
Capacity litres	7
Weight gr.	670
Standard colour*	■
Bottom	solid
Long sides	closed
Short sides	closed
Lifting	bars

Label holder: ORD. NO. **F PZ 0010 00 99**
See page G15

■ *On request other colours available

TROLLEY WITH STACKING CONTAINERS

ORD. NO.	DIM. mm
F LB B103 53 52	1023x613x1430 h
Including:	
1 trolley ORD. NO. F LB B103 03 52	
2 standard rubber swivel wheels with brakes Ø 125 mm	
2 standard rubber fixed wheels Ø 125 mm	
3 shelves depth 420 mm	
5 stacking containers ORD. NO. F PA 4451 A0 01	
2 stacking containers ORD. NO. F PA 6451 A0 01	
2 stacking containers ORD. NO. F PA 6851 A0 01	
Load capacity 300 kg (150 kg per side)	

■ For any further information: see page D2



ORD. NO. **F LB B103 53 52**

KEY



The stacking containers marked with this symbol can be used to store foodstuffs.



Containers with this symbol are made of completely recyclable plastic material.



GREY
F.....01

SERIES STORAGE ATHENA

■ 01

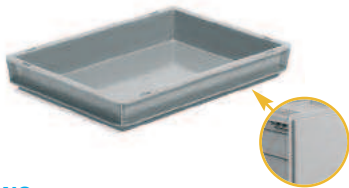
**ORD. NO.**

DIM. mm

F PA 3251 AO 01 400x300x55 h

External dim. mm 400x300x55 h

Internal dim. mm 355x254x37 h

Capacity litres 3,8

Weight gr. 505

Standard colour* ■

Bottom **solid**Long sides **closed**Short sides **closed**Lifting **bars**Label holder: ORD. NO. **F PZ 0010 00 99**

See page G15

■ 01

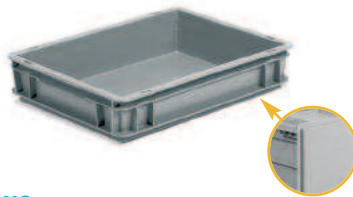
**ORD. NO.**

DIM. mm

F PA 3651 AO 01 400x300x78 h

External dim. mm 400x300x78 h

Internal dim. mm 355x255x59 h

Capacity litres 6

Weight gr. 550

Standard colour* ■

Bottom **solid**Long sides **closed**Short sides **closed**Lifting **bars**Label holder: ORD. NO. **F PZ 0010 00 99**

See pag. G15

■ 01

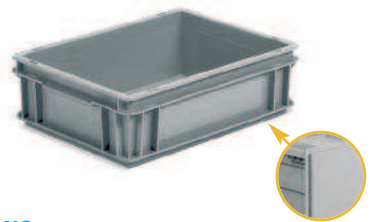
**ORD. NO.**

DIM. mm

F PA 4051 AO 01 400x300x120 h

External dim. mm 400x300x120 h

Internal dim. mm 357x257x102 h

Capacity litres 10

Weight gr. 770

Standard colour* ■

Bottom **solid**Long sides **closed**Short sides **closed**Lifting **bars**Label holder: ORD. NO. **F PZ 0010 00 99**

See pag. G15

■ 01

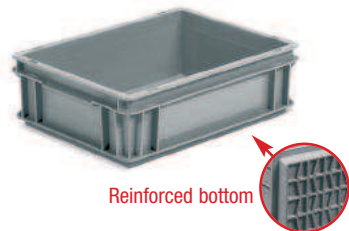
**ORD. NO.**

DIM. mm

F PA 4151 AO 01 400x300x125 h

External dim. mm 400x300x125 h

Internal dim. mm 357x256x94 h

Capacity litres 10

Weight gr. 1005

Standard colour* ■

Bottom **reinforced**Long sides **closed**Short sides **closed**Lifting **bars**Label holder: ORD. NO. **F PZ 0010 00 99**

See page G15

■ 01

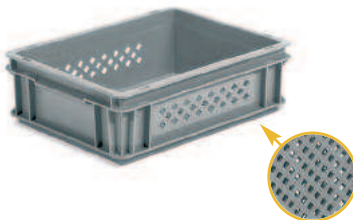
**ORD. NO.**

DIM. mm

F PA 4051 EO 01 400x300x120 h

External dim. mm 400x300x120 h

Internal dim. mm 357x256x99 h

Capacity litres 10

Weight gr. 820

Standard colour* ■

Bottom **perforated**Long sides **perforated**Short sides **closed**Lifting **bars**Label holder: ORD. NO. **F PZ 0010 00 99**

See page G15

■ 01

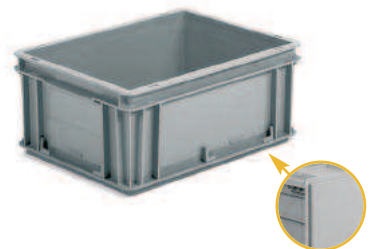
**ORD. NO.**

DIM. mm

F PA 4451 AO 01 400x300x170 h

External dim. mm 400x300x170 h

Internal dim. mm 357x257x152 h

Capacity litres 15

Weight gr. 1070

Standard colour* ■

Bottom **solid**Long sides **closed**Short sides **closed**Lifting **bars**Label holder: ORD. NO. **F PZ 0010 00 99**,ORD. NO. **F PZ 9551 00 07**. See page G15

■ *On request other colours available

GREY
F.....01

KEY ■



The stacking containers marked with this symbol can be used to store foodstuffs.



Containers with this symbol are made of completely recyclable plastic material.



DIMENSIONS = 400x300 mm

SERIES STORAGE ATHENA



ORD. NO.	DIM. mm
F PA 4551 A0 01	400x300x178 h
External dim. mm	400x300x178 h
Internal dim. mm	357x255x145 h
Capacity litres	15
Weight gr.	1485
Standard colour*	■
Bottom	reinforced
Long sides	closed
Short sides	closed
Lifting	bars
Label holder: ORD. NO. F PZ 0010 00 99 , ORD. NO. F PZ 9551 00 07 . See pag. G15	



ORD. NO.	DIM. mm
F PA 4851 A0 01	400x300x220 h
External dim. mm	400x300x220 h
Internal dim. mm	357x258x207 h
Capacity litres	20
Weight gr.	1230
Standard colour*	■
Bottom	solid
Long sides	closed
Short sides	closed
Lifting	bars
Label holder: ORD. NO. F PZ 0010 00 99 , ORD. NO. F PZ 9551 00 07 . See pag. G15	



ORD. NO.	DIM. mm
F PA 4851 B0 01	400x300x220 h
External dim. mm	400x300x220 h
Internal dim. mm	357x258x206 h
Capacity litres	20
Weight gr.	1200
Standard colour*	■
Bottom	solid
Long sides	closed
Short sides	closed
Lifting	holes
Label holder: ORD. NO. F PZ 0010 00 99 , ORD. NO. F PZ 9551 00 07 . See pag. G15	

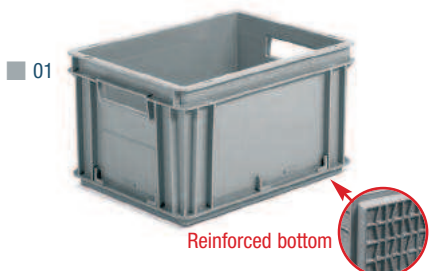

ORD. NO.	DIM. mm
F PA 4951 B0 01	400x300x230 h
External dim. mm	400x300x230 h
Internal dim. mm	356x257x197 h
Capacity litres	20
Weight gr.	1390
Standard colour*	■
Bottom	reinforced
Long sides	closed
Short sides	closed
Lifting	holes
Label holder: ORD. NO. F PZ 0010 00 99 , ORD. NO. F PZ 9551 00 07 . See page G15	



ORD. NO.	DIM. mm
F PA 5251 A0 01	400x300x325 h
External dim. mm	400x300x325 h
Internal dim. mm	356x255x307 h
Capacity litres	30
Weight gr.	2050
Standard colour*	■
Bottom	solid
Long sides	closed
Short sides	closed
Lifting	bars
Label holder: ORD. NO. F PZ 0010 00 99 , ORD. NO. F PZ 9551 00 07 . See page G15	



ORD. NO.	DIM. mm
F PA 5251 B0 01	400x300x325 h
External dim. mm	400x300x325 h
Internal dim. mm	355x255x305 h
Capacity litres	30
Weight gr.	2020
Standard colour*	■
Bottom	solid
Long sides	closed
Short sides	closed
Lifting	holes
Label holder: ORD. NO. F PZ 0010 00 99 , ORD. NO. F PZ 9551 00 07 . See page G15	

■ *On request other colours available

Athena series stacking containers
ORD. NO. **F PA 6851 B0 01**



■ KEY



The stacking containers marked with this symbol can be used to store foodstuffs.



Containers with this symbol are made of completely recyclable plastic material.



GREY
F.....01

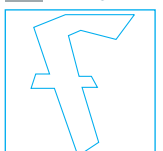

SERIES STORAGE ATHENA



ORD. NO. DIM. mm

F PA 5651 AO 01 600x400x76 h

External dim. mm 600x400x76 h

Internal dim. mm 555x353x58 h

Capacity litres 10

Weight gr. 1242

Standard colour* ■

Bottom **solid**

Long sides **closed**

Short sides **closed**

Lifting **bars**

Label holder: ORD. NO. **F PZ 0010 00 99**

See page G15

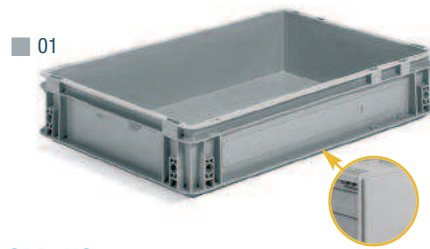

ORD. NO. DIM. mm

F PA 6051 AO 01 600x400x120 h

External dim. mm 600x400x120 h

Internal dim. mm 557x357x102 h

Capacity litres 20

Weight gr. 1585

Standard colour* ■

Bottom **solid**

Long sides **closed**

Short sides **closed**

Lifting **bars**

Label holder: ORD. NO. **F PZ 0010 00 99**

See page G15

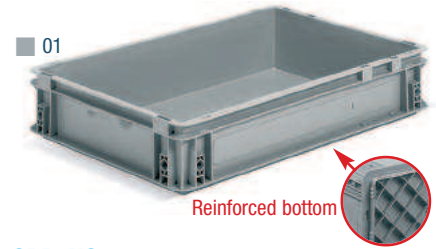

ORD. NO. DIM. mm

F PA 6151 AO 01 600x400x120 h

External dim. mm 600x400x120 h

Internal dim. mm 555x354x97 h

Capacity litres 20

Weight gr. 1685

Standard colour* ■

Bottom **reinforced**

Long sides **closed**

Short sides **closed**

Lifting **bars**

Label holder: ORD. NO. **F PZ 0010 00 99**

See page G15

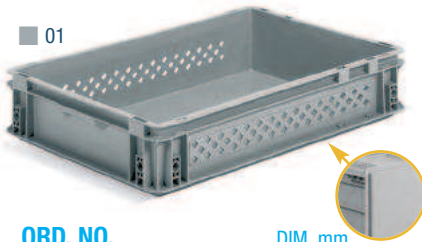

ORD. NO. DIM. mm

F PA 6051 CO 01 600x400x120 h

External dim. mm 600x400x120 h

Internal dim. mm 557x356x102 h

Capacity litres 20

Weight gr. 1575

Standard colour* ■

Bottom **solid**

Long sides **perforated**

Short sides **closed**

Lifting **bars**

Label holder: ORD. NO. **F PZ 0010 00 99**

See page G15

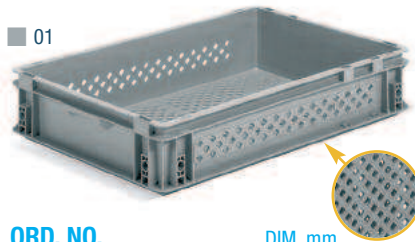

ORD. NO. DIM. mm

F PA 6051 EO 01 600x400x120 h

External dim. mm 600x400x120 h

Internal dim. mm 557x357x103 h

Capacity litres 20

Weight gr. 1500

Standard colour* ■

Bottom **perforated**

Long sides **perforated**

Short sides **closed**

Lifting **bars**

Label holder: ORD. NO. **F PZ 0010 00 99**

See page G15



TROLLEY

ORD. NO. DIM. mm

F CP 2011 02 99 615x415x170/870 h

Trolley with 4 standard rubber swivel wheels
without brakes Ø 100 mm

Load capacity 150 kg

without stacking containers

■ *On request other colours available

■ For any further information: see page E8

GREY
F.....01

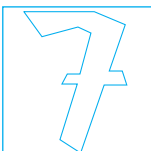

KEY ■



The stacking containers marked with this symbol can be used to store foodstuffs.



Containers with this symbol are made of completely recyclable plastic material.



DIMENSIONS = 600x400 mm

SERIES STORAGE ATHENA



ORD. NO.	DIM. mm
F PA 6451 AO 01	600x400x170 h
External dim. mm	600x400x170 h
Internal dim. mm	560x358x153 h
Capacity litres	30
Weight gr.	2125
Standard colour*	■
Bottom	solid
Long sides	closed
Short sides	closed
Lifting	bars

Label holder: ORD. NO. **F PZ 0010 00 99**,
ORD. NO. **F PZ 9751 00 07**. See page G15

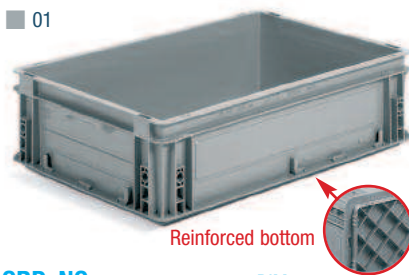

ORD. NO.	DIM. mm
F PA 6551 AO 01	600x400x170 h
External dim. mm	600x400x170 h
Internal dim. mm	558x358x139 h
Capacity litres	30
Weight gr.	2330
Standard colour*	■
Bottom	reinforced
Long sides	closed
Short sides	closed
Lifting	bars

Label holder: ORD. NO. **F PZ 0010 00 99**,
ORD. NO. **F PZ 9751 00 07**. See page G15



ORD. NO.	DIM. mm
F PA 6851 AO 01	600x400x220 h
External dim. mm	600x400x220 h
Internal dim. mm	558x356x202 h
Capacity litres	40
Weight gr.	2620
Standard colour*	■
Bottom	solid
Long sides	closed
Short sides	closed
Lifting	holes

Label holder: ORD. NO. **F PZ 0010 00 99**,
ORD. NO. **F PZ 9751 00 07**. See page G15



ORD. NO.	DIM. mm
F PA 6851 BO 01	600x400x220 h
External dim. mm	600x400x220 h
Internal dim. mm	558x357x202 h
Capacity litres	40
Weight gr.	2570
Standard colour*	■
Bottom	solid
Long sides	closed
Short sides	closed
Lifting	holes

Label holder: ORD. NO. **F PZ 0010 00 99**,
ORD. NO. **F PZ 9751 00 07**. See page G15

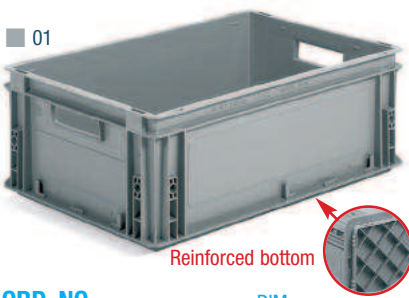

ORD. NO.	DIM. mm
F PA 6951 BO 01	600x400x220 h
External dim. mm	600x400x220 h
Internal dim. mm	560x358x188 h
Capacity litres	40
Weight gr.	2875
Standard colour*	■
Bottom	reinforced
Long sides	closed
Short sides	closed
Lifting	holes

Label holder: ORD. NO. **F PZ 0010 00 99**,
ORD. NO. **F PZ 9751 00 07**. See page G15

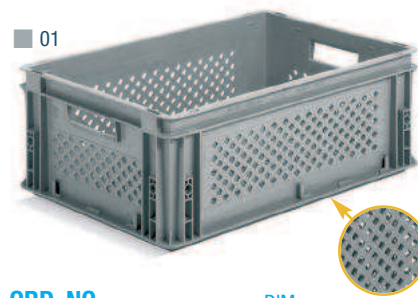

ORD. NO.	DIM. mm
F PA 6851 FO 01	600x400x220 h
External dim. mm	600x400x220 h
Internal dim. mm	557x356x202 h
Capacity litres	40
Weight gr.	2480
Standard colour*	■
Bottom	perforated
Long sides	perforated
Short sides	perforated
Lifting	holes

Label holder: ORD. NO. **F PZ 0010 00 99**,
ORD. NO. **F PZ 9751 00 07**. See page G15

■ *On request other colours available

TROLLEY

ORD. NO.
F CR 0441 00 04
Trolley with 2 polyurethane swivel wheels in rubber Ø 125 mm, 2 fixed wheels Ø 125 mm
Load capacity 300 kg
Only for lifting Athena and Odette series 600x400 mm

■ For any further information: see page G15



■ **KEY**



The stacking containers marked with this symbol can be used to store foodstuffs.



Containers with this symbol are made of completely recyclable plastic material.

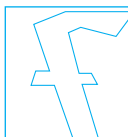

GREY
F... ..01

SERIES STORAGE ATHENA

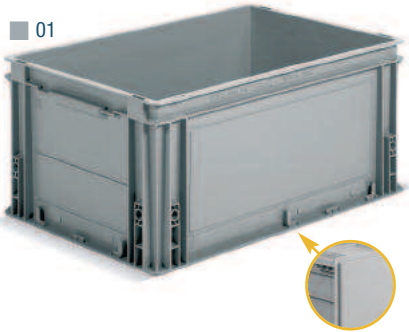

ORD. NO.	DIM. mm
F PA 7251 AO 01	600x400x285 h
External dim. mm	600x400x285 h
Internal dim. mm	557x356x263 h
Capacity litres	53
Weight gr.	2765
Standard colour*	■
Bottom	solid
Long sides	closed
Short sides	closed
Lifting	bars
Label holder: ORD. NO. F PZ 0010 00 99 , ORD. NO. F PZ 9751 00 07 . See page G15	



ORD. NO.	DIM. mm
F PA 7251 BO 01	600x400x285 h
External dim. mm	600x400x285 h
Internal dim. mm	557x357x263 h
Capacity litres	53
Weight gr.	2895
Standard colour*	■
Bottom	solid
Long sides	closed
Short sides	closed
Lifting	holes
Label holder: ORD. NO. F PZ 0010 00 99 , ORD. NO. F PZ 9751 00 07 . See page G15	

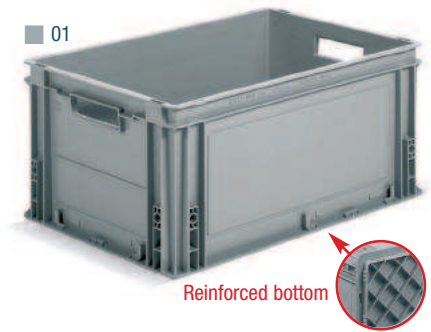

ORD. NO.	DIM. mm
F PA 7351 BO 01	600x400x285 h
External dim. mm	600x400x285 h
Internal dim. mm	557x357x256 h
Capacity litres	53
Weight gr.	3120
Standard colour*	■
Bottom	reinforced
Long sides	closed
Short sides	closed
Lifting	holes
Label holder: ORD. NO. F PZ 0010 00 99 , ORD. NO. F PZ 9751 00 07 . See page G15	



ORD. NO.	DIM. mm
F PA 7651 AO 01	600x400x325 h
External dim. mm	600x400x325 h
Internal dim. mm	558x358x308 h
Capacity litres	60
Weight gr.	3315
Standard colour*	■
Bottom	solid
Long sides	closed
Short sides	closed
Lifting	bars
Label holder: ORD. NO. F PZ 0010 00 99 , ORD. NO. F PZ 9751 00 07 . See page G15	



ORD. NO.	DIM. mm
F PA 7651 BO 01	600x400x325 h
External dim. mm	600x400x325 h
Internal dim. mm	558x357x308 h
Capacity litres	60
Weight gr.	3215
Standard colour*	■
Bottom	solid
Long sides	closed
Short sides	closed
Lifting	holes
Label holder: ORD. NO. F PZ 0010 00 99 , ORD. NO. F PZ 9751 00 07 . See page G15	

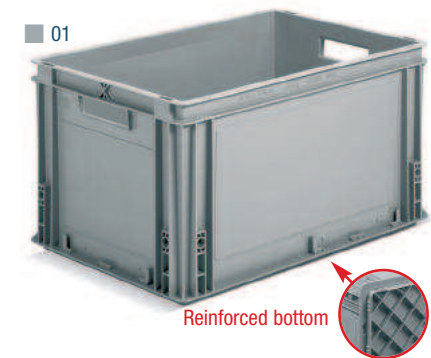

ORD. NO.	DIM. mm
F PA 7751 BO 01	600x400x325 h
External dim. mm	600x400x325 h
Internal dim. mm	558x358x295 h
Capacity litres	60
Weight gr.	3630
Standard colour*	■
Bottom	reinforced
Long sides	closed
Short sides	closed
Lifting	holes
Label holder: ORD. NO. F PZ 0010 00 99 , ORD. NO. F PZ 9751 00 07 . See page G15	

■ *On request other colours available

GREY
F.....01

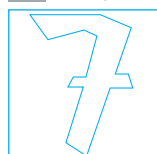

KEY ■



The stacking containers marked with this symbol can be used to store foodstuffs.



Containers with this symbol are made of completely recyclable plastic material.



DIMENSIONS = 600x400 mm

SERIES STORAGE ATHENA

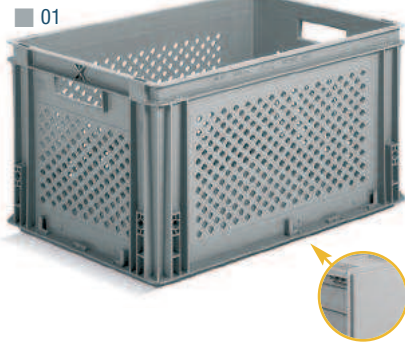

ORD. NO.	DIM. mm
F PA 7651 DO 01	600x400x325 h
External dim. mm	600x400x325 h
Internal dim. mm	558x358x308 h
Capacity litres	60
Weight gr.	3040
Standard colour*	■
Bottom	solid
Long sides	perforated
Short sides	perforated
Lifting	holes
Label holder: ORD. NO. F PZ 0010 00 99 , ORD. NO. F PZ 9751 00 07 . See page G15	

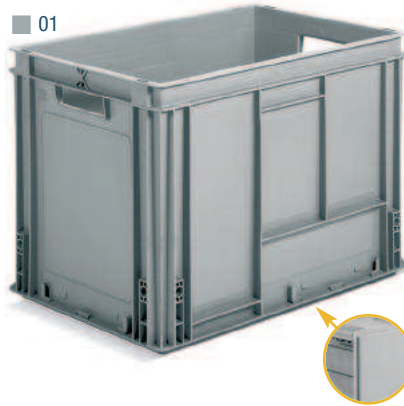

ORD. NO.	DIM. mm
F PA 8051 BO 01	600x400x430 h
External dim. mm	600x400x430 h
Internal dim. mm	557x356x415 h
Capacity litres	90
Weight gr.	3915
Standard colour*	■
Bottom	solid
Long sides	closed
Short sides	closed
Lifting	holes
Label holder: ORD. NO. F PZ 0010 00 99 , ORD. NO. F PZ 9751 00 07 . See page G15	

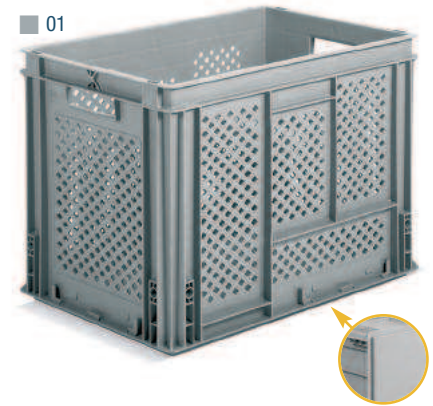

ORD. NO.	DIM. mm
F PA 8051 DO 01	600x400x430 h
External dim. mm	600x400x430 h
Internal dim. mm	557x357x415 h
Capacity litres	90
Weight gr.	3610
Standard colour*	■
Bottom	solid
Long sides	perforated
Short sides	perforated
Lifting	holes
Label holder: ORD. NO. F PZ 0010 00 99 , ORD. NO. F PZ 9751 00 07 . See page G15	

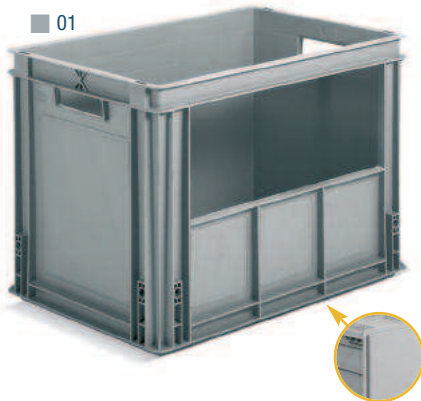

ORD. NO.	DIM. mm
F PA 8051 SO 01	600x400x430 h
External dim. mm	600x400x430 h
Internal dim. mm	557x357x415 h
Window dim. mm	462x180 h
Capacity litres	90
Weight gr.	3625
Standard colour*	■
Bottom	solid
Long sides	closed
Short sides	closed
Lifting	holes
Label holder: ORD. NO. F PZ 0010 00 99 , ORD. NO. F PZ 9751 00 07 . See page G15	

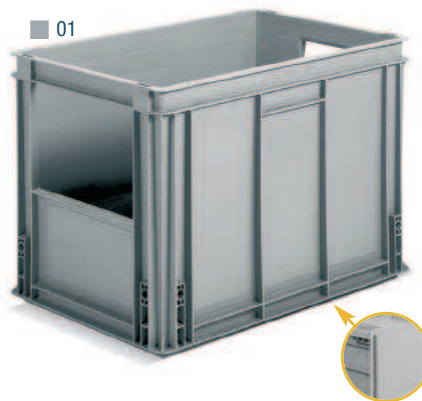

ORD. NO.	DIM. mm
F PA 8051 RO 01	600x400x430 h
External dim. mm	600x400x430 h
Internal dim. mm	557x357x415 h
Window dim. mm	260x183 h
Capacity litres	90
Weight gr.	3780
Standard colour*	■
Bottom	solid
Long sides	closed
Short sides	closed
Lifting	holes
Label holder: ORD. NO. F PZ 0010 00 99 , ORD. NO. F PZ 9751 00 07 . See page G15	

*On request other colours available

■ KEY



The stacking containers marked with this symbol can be used to store foodstuffs.



Containers with this symbol are made of completely recyclable plastic material.



GREY
F... ..01

SERIES STORAGE ATHENA

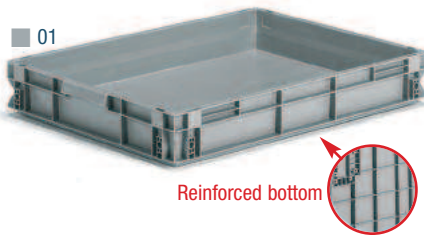

Reinforced bottom

ORD. NO.	DIM. mm
F PA 8551 AO 01	800x600x120 h
External dim. mm	800x600x120 h
Internal dim. mm	757x557x86 h
Capacity litres	49
Weight gr.	3450
Standard colour*	■
Bottom	reinforced
Long sides	closed
Short sides	closed
Lifting	bars

Label holder: ORD. NO. **F PZ 0010 00 99**
See page G15

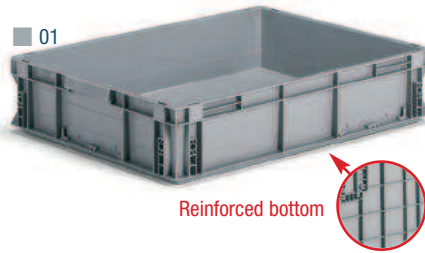

Reinforced bottom

ORD. NO.	DIM. mm
F PA 8751 AO 01	800x600x170 h
External dim. mm	800x600x170 h
Internal dim. mm	758x555x137 h
Capacity litres	69
Weight gr.	3920
Standard colour*	■
Bottom	reinforced
Long sides	closed
Short sides	closed
Lifting	bars

Label holder: ORD. NO. **F PZ 0010 00 99**,
ORD. NO. **F PZ 9751 00 07**. See page G15

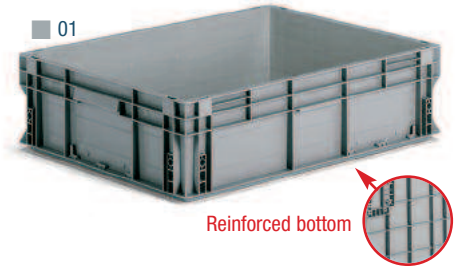

Reinforced bottom

ORD. NO.	DIM. mm
F PA 8951 AO 01	800x600x220 h
External dim. mm	800x600x220 h
Internal dim. mm	757x556x188 h
Capacity litres	90
Weight gr.	4630
Standard colour*	■
Bottom	reinforced
Long sides	closed
Short sides	closed
Lifting	bars

Label holder: ORD. NO. **F PZ 0010 00 99**,
ORD. NO. **F PZ 9751 00 07**. See page G15

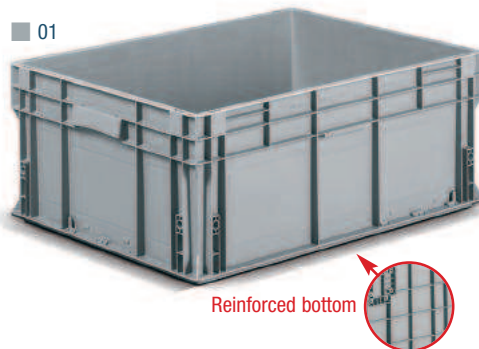

Reinforced bottom

ORD. NO.	DIM. mm
F PA 9351 AO 01	800x600x325 h
External dim. mm	800x600x325 h
Internal dim. mm	756x555x294 h
Capacity litres	130
Weight gr.	5270
Standard colour*	■
Bottom	reinforced
Long sides	closed
Short sides	closed
Lifting	bars

Label holder: ORD. NO. **F PZ 0010 00 99**,
ORD. NO. **F PZ 9751 00 07**. See page G15

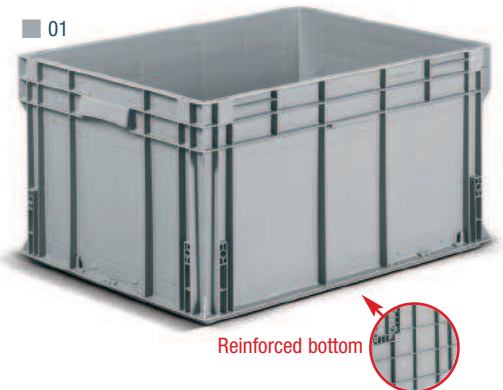

Reinforced bottom

ORD. NO.	DIM. mm
F PA 9751 AO 01	800x600x430 h
External dim. mm	800x600x430 h
Internal dim. mm	756x555x395 h
Capacity litres	175
Weight gr.	6200
Standard colour*	■
Bottom	reinforced
Long sides	closed
Short sides	closed
Lifting	bars

Label holder: ORD. NO. **F PZ 0010 00 99**,
ORD. NO. **F PZ 9751 00 07**. See page G15



■ Detail of stacking containers with reinforced bottom 800x600 mm

■ *On request other colours available

GREY
F.....01

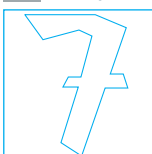

KEY ■



The stacking containers marked with this symbol can be used to store foodstuffs.



Containers with this symbol are made of completely recyclable plastic material.



DIMENSIONS = 800x600 mm

SERIES STORAGE ATHENA

CONTAINER INCLUDING 1 SET OF FOUR FEET

- Supplied assembled



ORD. NO.	DIM. mm
F PA 8551 AD 01	800x600x220 h
With 120 mm high container	
Capacity litres	49
ORD. NO.	DIM. mm
F PA 8751 AD 01	800x600x270 h
With 170 mm high container	
Capacity litres	69
ORD. NO.	DIM. mm
F PA 8951 AD 01	800x600x320 h
With 220 mm high container	
Capacity litres	90
ORD. NO.	DIM. mm
F PA 9351 AD 01	800x600x425 h
With 325 mm high container	
Capacity litres	130
ORD. NO.	DIM. mm
F PA 9751 AD 01	800x600x530 h
With 430 mm high container	
Capacity litres	175

CONTAINER INCLUDING 1 SET OF FOUR FEET AND 1 PAIR OF CONNECTION PIECES

- Supplied assembled



ORD. NO.	DIM. mm
F PA 8551 AE 01	800x600x245 h
With 120 mm high container	
Capacity litres	49
ORD. NO.	DIM. mm
F PA 8751 AE 01	800x600x295 h
With 170 mm high container	
Capacity litres	69
ORD. NO.	DIM. mm
F PA 8951 AE 01	800x600x345 h
With 220 mm high container	
Capacity litres	90
ORD. NO.	DIM. mm
F PA 9351 AE 01	800x600x450 h
With 325 mm high container	
Capacity litres	130
ORD. NO.	DIM. mm
F PA 9751 AE 01	800x600x555 h
With 430 mm high container	
Capacity litres	175

CONTAINER INCLUDING 1 SET OF FOUR Ø 100 mm RUBBER SWIVEL WHEELS

- Supplied assembled



ORD. NO.	DIM. mm
F PA 8551 AF 01	800x600x245 h
With 120 mm high container	
Capacity litres	49
ORD. NO.	DIM. mm
F PA 8751 AF 01	800x600x295 h
With 170 mm high container	
Capacity litres	69
ORD. NO.	DIM. mm
F PA 8951 AF 01	800x600x345 h
With 220 mm high container	
Capacity litres	90
ORD. NO.	DIM. mm
F PA 9351 AF 01	800x600x450 h
With 325 mm high container	
Capacity litres	130
ORD. NO.	DIM. mm
F PA 9751 AF 01	800x600x555 h
With 430 mm high container	
Capacity litres	175

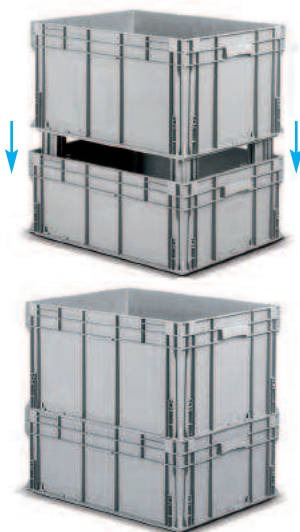

- The containers can be stacked thanks to the 4 feet which enter inside the container below



- The 2 connection pieces allow the containers to be stacked

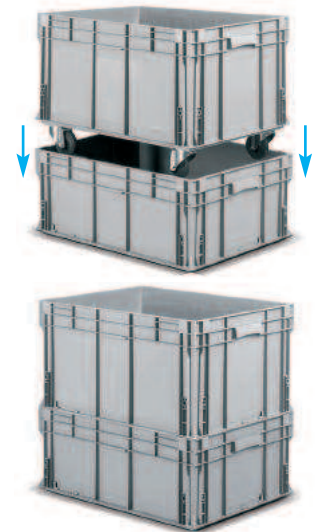

- The containers can be stacked thanks to the 4 wheels which enter inside the container below

■ KEY



The stacking containers marked with this symbol can be used to store foodstuffs.



Containers with this symbol are made of completely recyclable plastic material.



GREY
F.....01

SERIES STORAGE ATHENA

HINGED LID SERIES F PA 300x200 / 400x300 / 600x400



Hinged lid

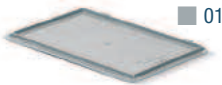

01

ORD. NO.

Hinged lid mm

F PA 0351 00 01

300x200

Weight gr. 155

Standard colour* ■

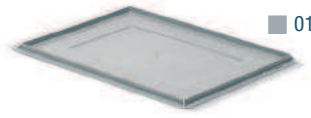

01

ORD. NO.

Hinged lid mm

F PA 0651 00 01

400x300

Weight gr. 320

Standard colour* ■

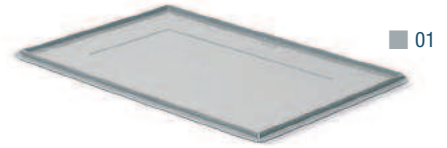

01

ORD. NO.

Hinged lid mm

F PA 0951 00 01

600x400

Weight gr. 722

Standard colour* ■

COVER SERIES F PA 400x300 / 600x400 / 800x600



Cover

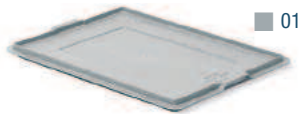

01

ORD. NO.

Lid mm

F PA 1B51 00 01

400x300

Weight gr. 375

Standard colour* ■



01

ORD. NO.

Lid mm

F PA 1C51 00 01

600x400

Weight gr. 750

Standard colour* ■



01

ORD. NO.

Lid mm

F PA 1251 01 01

800x600

Weight gr. 1685

Standard colour* ■

For containers ORD. NO. F PA 8551 A0 01



01

ORD. NO.

Lid mm

F PA 1251 00 01

800x600

Weight gr. 1710

Standard colour* ■

For containers ORD. NO. F PA 8751 A0 01, F PA 8951 A0 01, F PA 9351 A0 01, F PA 9751 A0 01

■ *On request other colours available

SLIDING LID SERIES F PA 400x300



Sliding lid



01

ORD. NO.

Sliding lid mm

F PA 1651 00 01

400x300

Weight gr. 440

Standard colour* ■

■ Not suitable for ORD. NO. F PA 3251 A0 01

ORD. NO. F PZ 0681 00 13

Pair of sliding hooks suitable for Athena series containers with the following heights: 50/120/170/220/320/430 mm.

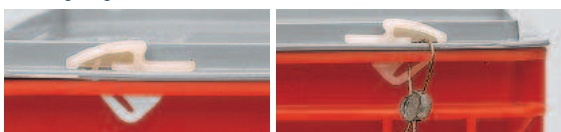

■ Kick-in locks not suitable for stacking containers
ORD. NO. F PA 5651 A0 ..

GREY
F.....01

KEY ■



The stacking containers marked with this symbol can be used to store foodstuffs.



Containers with this symbol are made of completely recyclable plastic material.



DIMENSIONS = 400x300 / 600x400 mm

SERIES STORAGE ATHENA

SUB-DIVIDING CONTAINERS FOR SERIES ATHENA 400x300

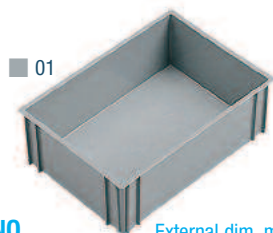

ORD. NO. External dim. mm
F PP 4051 00 01 250x176x90 h
Standard colour

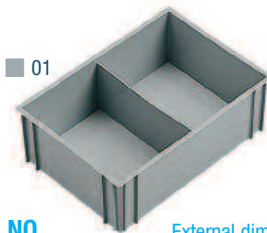

ORD. NO. External dim. mm
F PP 4551 00 01 256x176x90 h
Standard colour

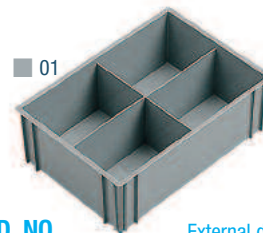

ORD. NO. External dim. mm
F PP 5051 00 01 256x176x90 h
Standard colour

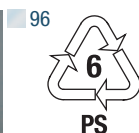
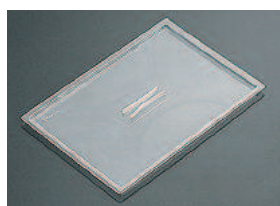

ORD. NO. External dim. mm
F PP 9368 00 96 252x178
Colour transparent

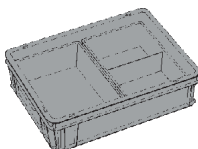

STACKING CONTAINER DIVIDED WITH
1 ORD. NO. F PP 4051 00 01
1 ORD. NO. F PP 4551 00 01

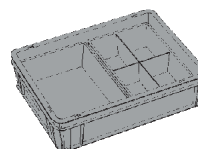

STACKING CONTAINER DIVIDED WITH
1 ORD. NO. F PP 4051 00 01
1 ORD. NO. F PP 5051 00 01

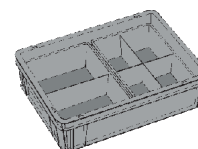

STACKING CONTAINER DIVIDED WITH
1 ORD. NO. F PP 4551 00 01
1 ORD. NO. F PP 5051 00 01

SUB-DIVIDING CONTAINERS FOR SERIES ATHENA - THEMA 600x400

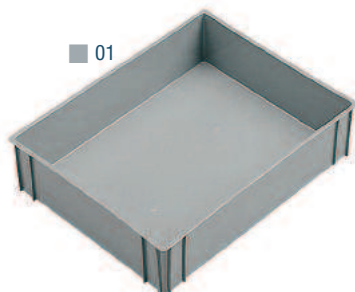

ORD. NO. External dim. mm
F PP 6051 00 01 358x278x90 h
Standard colour

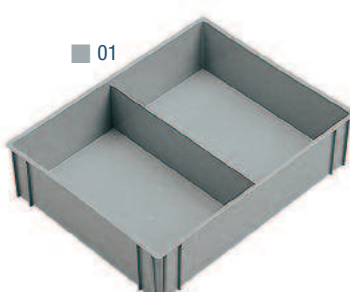

ORD. NO. External dim. mm
F PP 6551 00 01 358x278x90 h
Standard colour

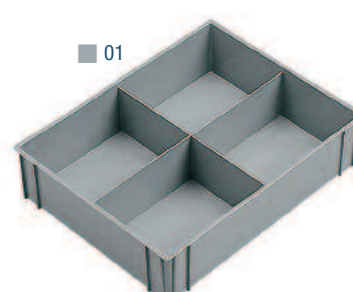

ORD. NO. External dim. mm
F PP 7051 00 01 358x278x90 h
Standard colour

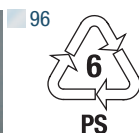
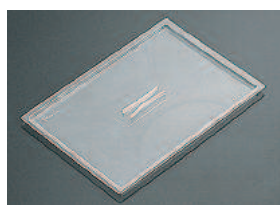

ORD. NO. External dim. mm
F PP 9668 00 96 358x278
Colour transparent

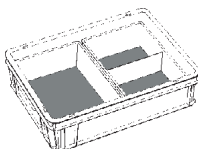

STACKING CONTAINER DIVIDED WITH
1 ORD. NO. F PP 6051 00 01
1 ORD. NO. F PP 6551 00 01

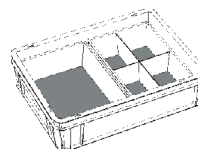

STACKING CONTAINER DIVIDED WITH
1 ORD. NO. F PP 6051 00 01
1 ORD. NO. F PP 7051 00 01

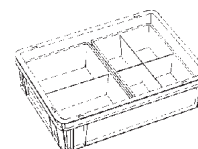

STACKING CONTAINER DIVIDED WITH
1 ORD. NO. F PP 6551 00 01
1 ORD. NO. F PP 7051 00 01

KEY



Containers with this symbol are made of completely recyclable plastic material.



TRANSPARENT
F. 99

GREY
F. 01



SERIES STORAGE ATHENA

SLOTTED PARTITIONS FOR STACKING CONTAINERS SERIES
ATHENA - THEMA

HEIGHT mm 45 h

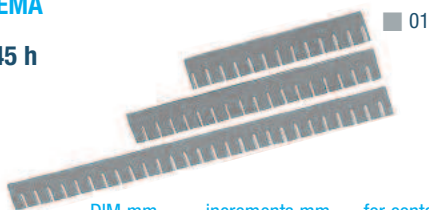

ORD. NO.	DIM mm	increments mm	for containers series
F HN 1320 00 01	255x45	20	400x300
F HN 1420 00 01	355x45	20	400x300 / 600x400
F HN 1620 00 01	555x45	20	600x400



HEIGHT mm 70 h

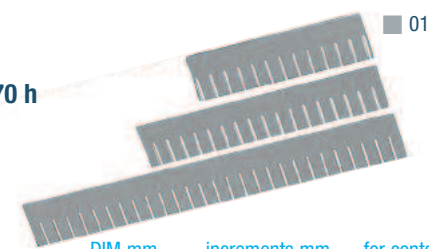

ORD. NO.	DIM mm	increments mm	for containers series
F HN 1340 00 01	255x70	20	400x300
F HN 1440 00 01	355x70	20	400x300 / 600x400
F HN 1640 00 01	555x70	20	600x400

HEIGHT mm 90 h

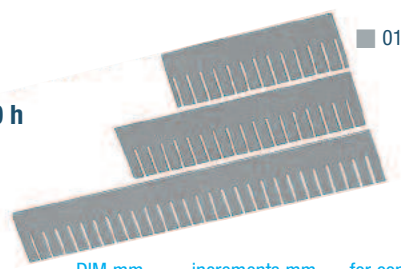

ORD. NO.	DIM mm	increments mm	for containers series
F HN 1350 00 01	255x90	20	400x300
F HN 1450 00 01	355x90	20	400x300 / 600x400
F HN 1650 00 01	555x90	20	600x400

HEIGHT mm 120 h

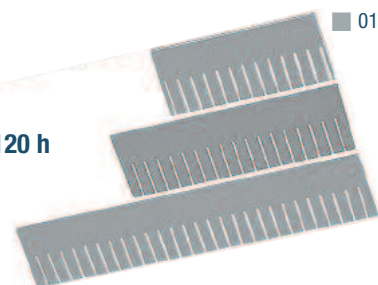

ORD. NO.	DIM mm	increments mm	for containers series
F HN 1360 00 01	255x120	20	400x300
F HN 1460 00 01	355x120	20	400x300 / 600x400
F HN 1660 00 01	555x120	20	600x400

HEIGHT mm 180 h

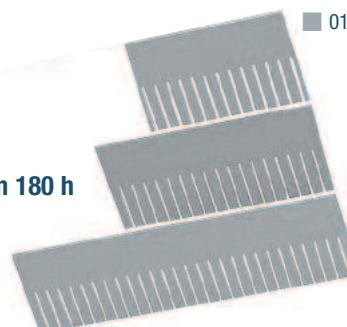

ORD. NO.	DIM mm	increments mm	for containers series
F HN 1370 00 01	255x180	20	400x300
F HN 1470 00 01	355x180	20	400x300 / 600x400
F HN 1670 00 01	555x180	20	600x400

COVER OR LAYER SEPARATOR

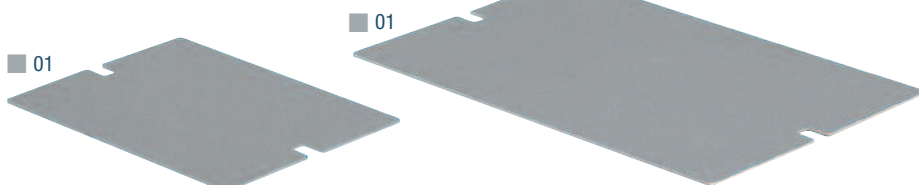

ORD. NO.	DIM. mm
F HN 5130 00 01	355x255
For containers Athena-Thema	400x300
Standard colour ■	

ORD. NO.	DIM. mm
F HN 5140 00 01	555x355
For containers Athena-Thema	600x400
Standard colour ■	

■ example of use as a cover or layer separator

GREY
F.....01

INFO ■

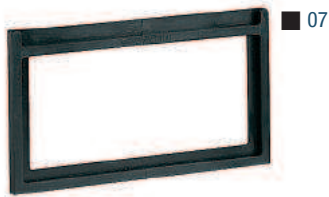

www.famispa.com

LABEL HOLDER FOR ATHENA AND NETTUNO SERIES 400x300

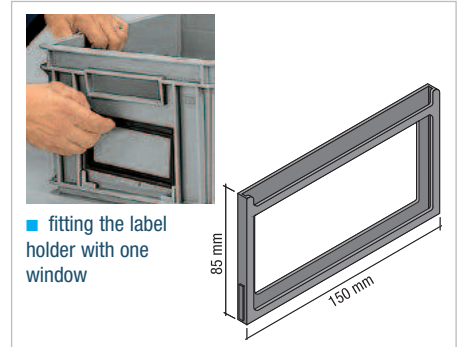

ORD. NO.	External dim. mm
F PZ 9551 00 07	150x85
Standard colour ■	

LABEL	ORD. NO.	External dim. mm
	F PZ 0920 00 00	145x81
Quantity per sheet: 4		



■ fitting the label holder with one window

LABEL HOLDER FOR ATHENA AND NETTUNO SERIES 600x400



ORD. NO.	External dim. mm
F PZ 9751 00 07	215x85
Standard colour ■	

LABEL	ORD. NO.	External dim. mm
	F PZ 0940 00 00	210x81
Quantity per sheet: 3		

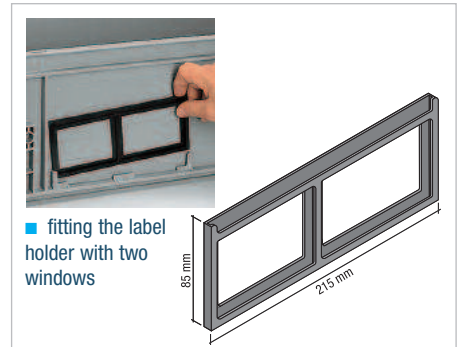

■ fitting the label holder with two windows

METAL CLIPS FOR ATHENA - THEMA - MINERVA SERIES



ORD. NO. F PZ 0010 00 99

■ 99

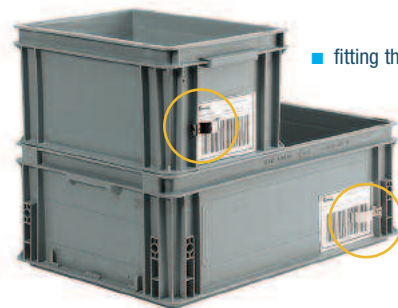

■ fitting the metal clip

TROLLEYS FOR LIFTING AND TRANSPORTING STORAGE AND STACKING CONTAINERS SERIES ATHENA - ODETTTE 600x400 mm

ORD. NO.	LOAD CAPACITY kg
F CR 0441 00 04	300
Only for lifting series Athena and Odette 600x400 mm	
2 swivel wheels in rubber Ø 125 mm	
2 fixed wheels in polyurethane Ø 125 mm	

■ 04



■ Only for lifting series Athena and Odette 600x400 mm

transport system

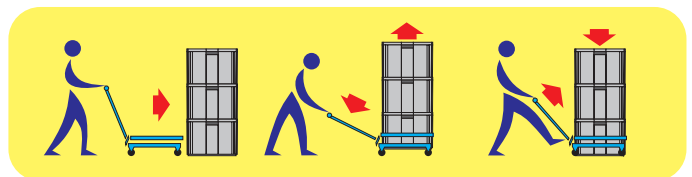

■ INFO

RAL 5012 F.04

GALVANISED F.99

BLACK F.07



www.famispa.com

